

Series ST Stopper cylinders

Single and double-acting, magnetic, non-rotating
Sizes 20, 32, 40, 50 mm



The Series ST Stopper cylinders are pneumatic actuators with rod, complying with UNITOP and ISO 21287 standards, where rod and bushing have been specifically enlarged to ensure high resistance to radial loads and shocks. These cylinders are available in two versions, double-acting and single-acting, and with rear spring. The non-rotating rod version is also available.

The detection of the piston position is enabled by means of proximity switches (Mod. CST or CSH) which are mounted in slots along three sides of the cylinder profile. It is possible to cover the slots with a proper profile (Mod. S-CST-500). The high resistance to shocks and radial loads and the easy mounting makes Series ST particularly suitable for use in transport/conveyor lines where it is required to stop the transit of workpieces and workpiece-holder pallets.

- » In compliance with UNITOP and ISO 21287 standards
- » Compact design
- » Can be used with magnetic sensors
- » Reliable and silent
- » Non-rotating rod version
- » Roller rod version
- » Female threaded rod version
- » High capacity to absorb kinetic energy of workpiece-holder pallets
- » Mechanical end-stroke shock absorbers
- » schéma d'application totale

GENERAL DATA

Construction	profile with self-tapping screws
Cylinder design	compact based on UNITOP and ISO 21287 standards
Operation	double-acting, single-acting rear spring, double-acting rear spring
Sizes	20, 32, 40 (Mod. ST32 only), 50 mm
Strokes (min - max)	5 ÷ 30 mm (see the table of standard strokes)
Rod versions	without thread, with female thread, non-rotating, non-rotating with female thread, non-rotating with roller
Non-rotating function	with technopolymer anti-friction ring
Fixing and mounting	direct with holes on the end-caps, in any position
Type of cushioning	mechanical end-stroke shock absorbers in rubber
Max frequency	5 Hz (Ø 20, 32, 40 mm) - 3 Hz (Ø 50 mm)
Working temperature	0°C ÷ 80°C (with dry air -20°C)
Storage temperature	-20°C ÷ 100°C
Working pressure	1 ÷ 10 bar (double-acting) - 2 ÷ 10 bar (single-acting)
Max rotation play	± 4° (Ø 20, 32 e 40 mm) - ± 3° (Ø 50 mm)
Max torque (for non-rotating version)	1.5 Nm (Ø 20 mm) - 2.5 Nm (Ø 32 e 40 mm) - 3.5 Nm (Ø 50 mm)
Medium	filtered air in class 7.8.4 according to ISO 8573-1 standard.
Lubrication	Not required. The cylinder is pre-lubricated. If lubricated air is used, it is recommended to use oil ISOVG32. Once applied the lubrication should never be interrupted.
Use with external sensors	slots on the three sides for proximity switches Mod. CST and CSH

STANDARD STROKES

✕ = Single-acting and double-acting

STANDARD STROKES						
Mod.	∅	10	15	20	25	30
ST31	20		✕			
ST31	32			✕		
ST31	50					✕
ST32	20	✕	✕			
ST32	32		✕	✕	✕	
ST32	40			✕	✕	✕
ST32	50			✕	✕	✕

CODING EXAMPLE

ST	31	2	A	050	A	030
-----------	-----------	----------	----------	------------	----------	------------

ST	SERIES	
31	CONSTRUCTION STANDARD: 31 = UNITOP 32 = ISO 21287	
2	OPERATION: 2 = double-acting 4 = single-acting, rear spring 9 = double-acting, rear spring	PNEUMATIC SYMBOLS: CD20 / CD08 CS15 / CS08 CS16 / CS17
A	DESIGN: A = standard R = non-rotating (for Mod. ST32 only)	
050	BORE: 020 = 20 mm 032 = 32 mm 040 = 40 mm (for Mod. ST32 only) 050 = 50 mm	
A	CONSTRUCTION: A = standard R = with roller (for non-rotating version only) F = with female thread (for Mod. ST32 only)	
030	STROKE (see the table)	
	VERSION: = standard (___) = extended piston rod ___ mm	

PNEUMATIC SYMBOLS

The pneumatic symbols which have been indicated in the CODING EXAMPLE are shown below.

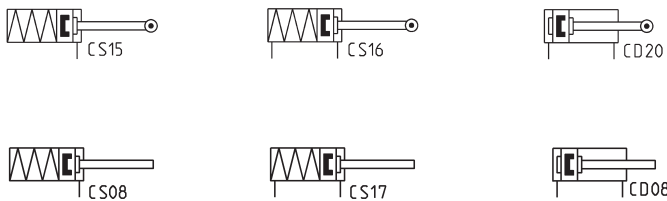

SERIES ST MATERIALS

PARTS	MATERIALS
1 - Rod	Stainless steel
2 - Profile	Anodized aluminium
3 - Head	Anodized aluminium
4 - Spring	Steel
5 - Piston seal	PU
6 - Magnet	Plastoferrite
7 - Rod seal	PU
8 - Rod guide bushing	Technopolymer
9 - Non-rotating ring	Technopolymer
10 - Roller	Stainless steel

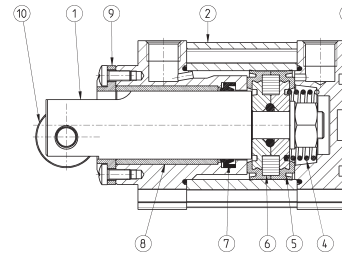
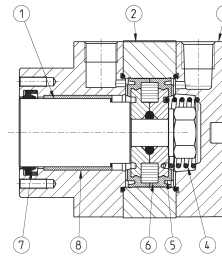

SERIES ST STOPPER CYLINDERS

EXAMPLES OF FIXING

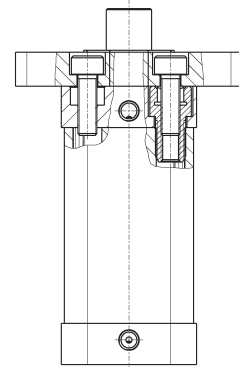
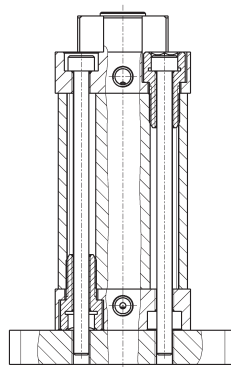
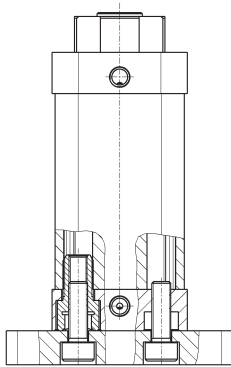

Fixing from below

Fixing from above

IMPACT FORCE

Between the mass to stop and the stopper rod, an elastic bumper is assumed to be inserted, which is capable of absorbing the impact by deforming at least 1mm.

	20	32	40	50
ST	1320 (N)	3200 (N)	-	6200 (N)
ST...R	820 (N)	2600 (N)	4450 (N)	5900 (N)

DIAGRAMS OF MASS/ IMPACT SPEED

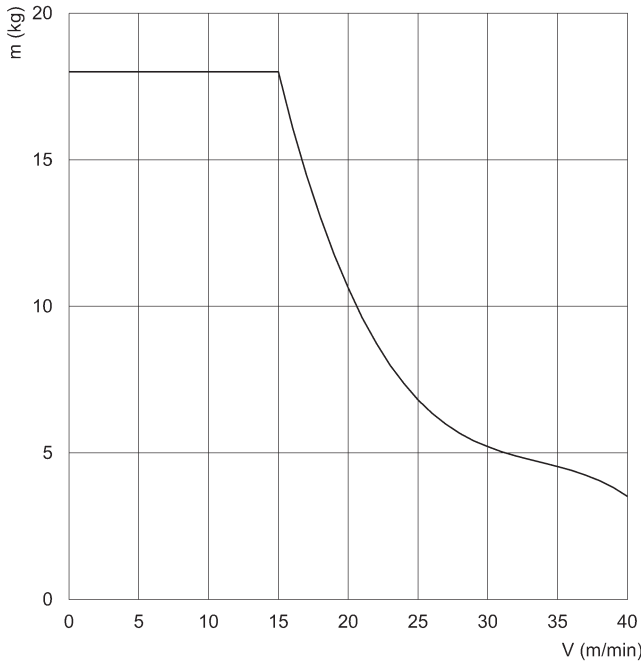

Cylinders Ø 20 mm

m = mass (kg)
V = impact speed (m/min)

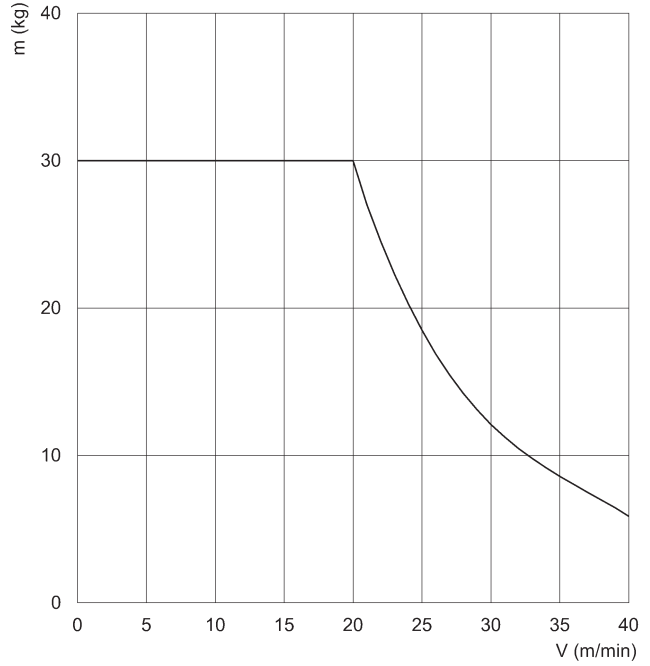

Cylinders Ø 32 mm

m = mass (kg)
V = impact speed (m/min)

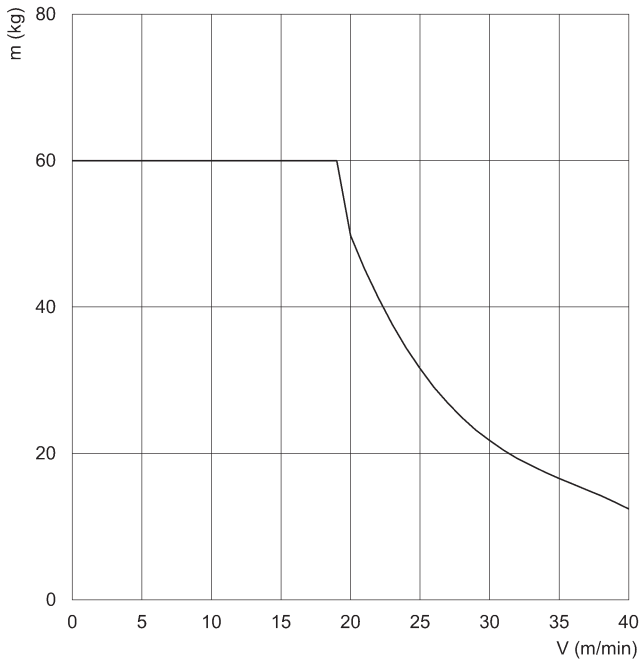

Cylinders Ø 40 mm

m = mass (kg)
V = impact speed (m/min)

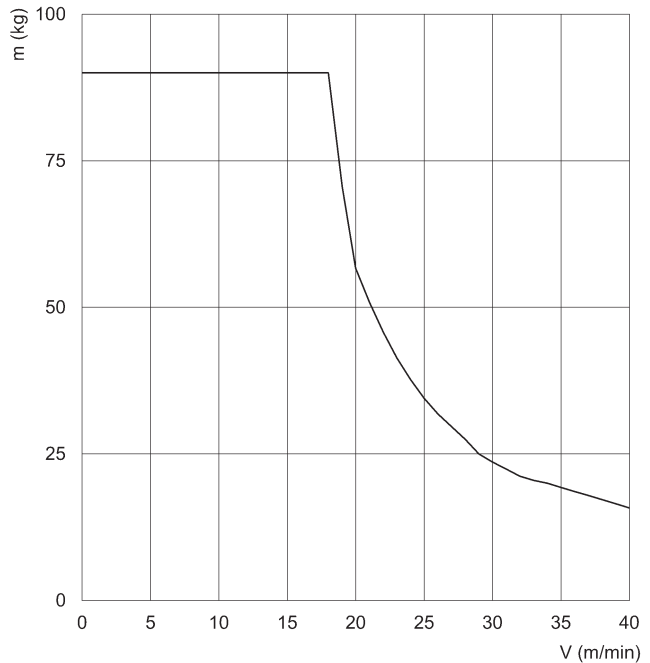

Cylinders Ø 50 mm

m = mass (kg)
V = impact speed (m/min)

DIAGRAMS OF APPLICABLE LATERAL FORCES DURING OPERATION

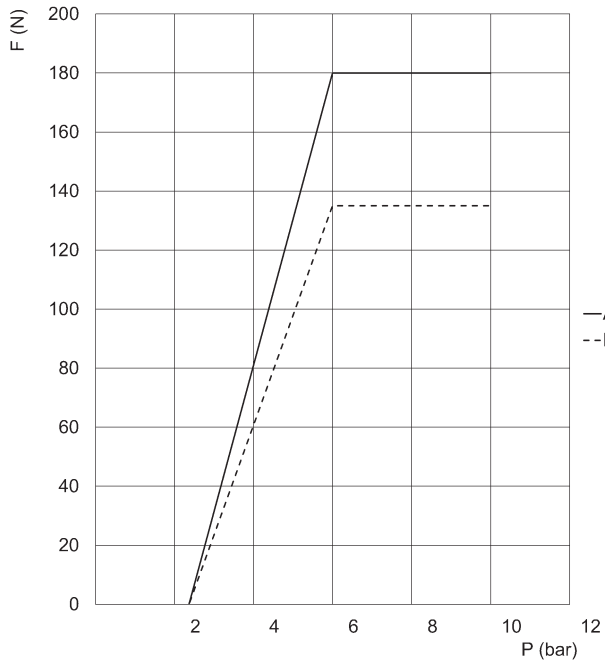

Cylinders \varnothing 20 mm, standard (A) and non-rotating (R) version

P = Pressure (bar)
F = applicable lateral Force (N)

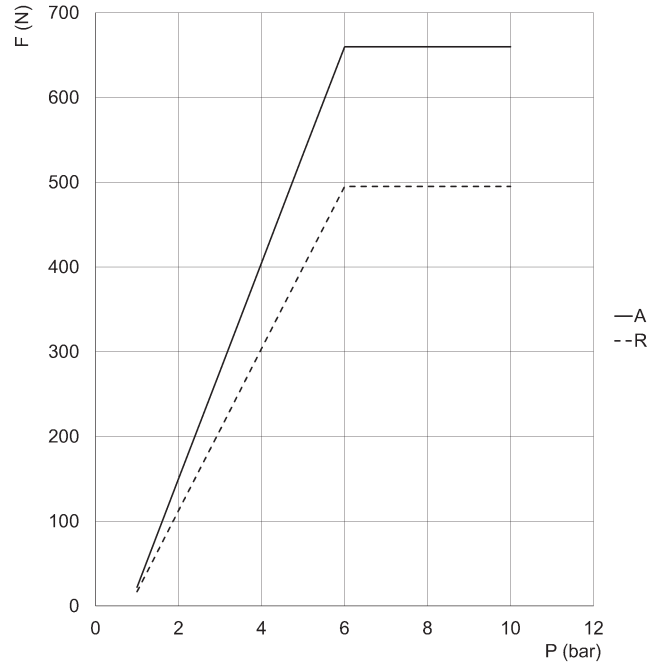

Cylinders \varnothing 32 mm, standard (A) and non-rotating (R) version

P = Pressure (bar)
F = applicable lateral Force (N)

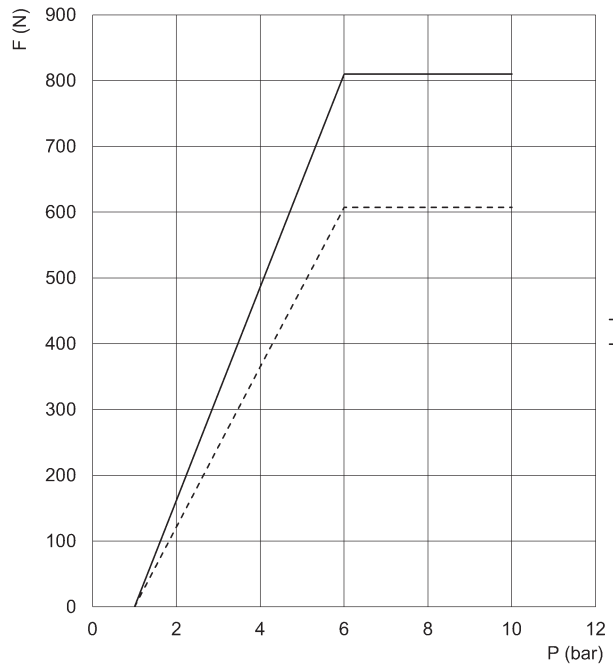

Cylinders \varnothing 40 mm, standard (A) and non-rotating (R) version

P = Pressure (bar)
F = applicable lateral Force (N)

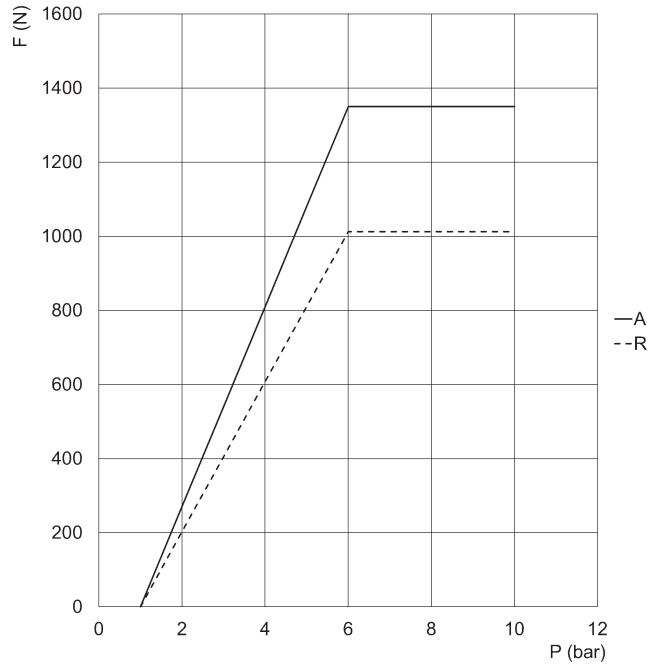

Cylinders \varnothing 50 mm, standard (A) and non-rotating (R) version

P = Pressure (bar)
F = applicable lateral Force (N)

DIAGRAM OF THE SPRING FORCES ACCORDING TO THE CYLINDER STROKE

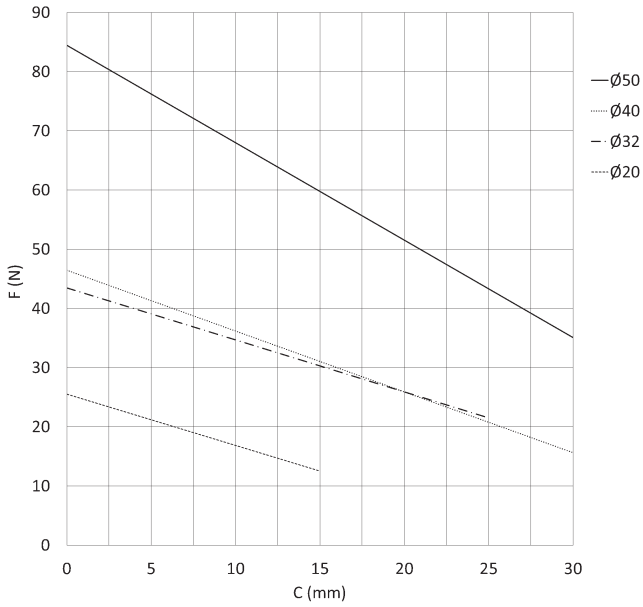

F = Force
C = Stroke

Stopper cylinders Mod. ST31 (UNITOP)

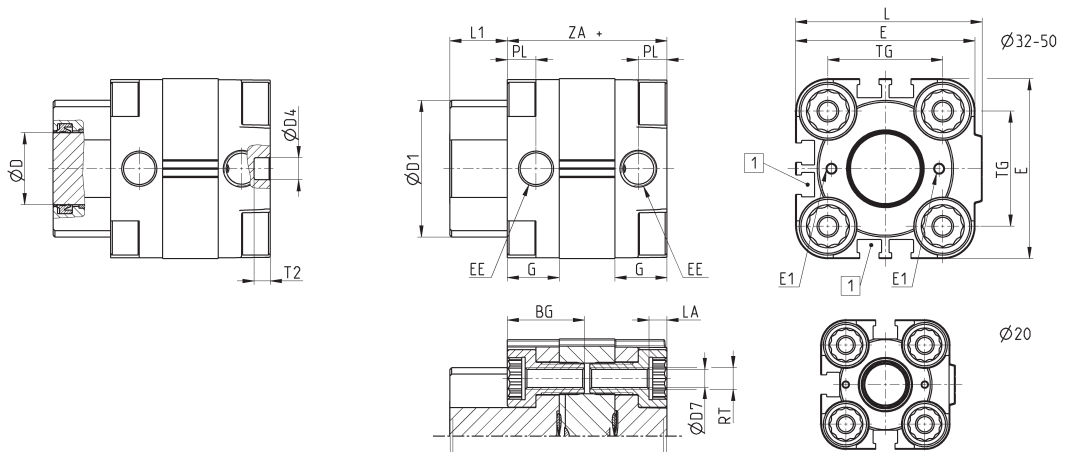

Ø	BG	G	ØD	ØD1	ØD4	ØD7	E	EE	E1	L	LA	L1	PL	RT	T2	TG	ZA	ZB
20	18.5	12	12	26	6	4	35.5	G1/8	M2	38	5	11.5	8	M5	4.5	22	38	49.5
32	21.5	14.5	20	38	6	5	50	G1/8	M3	52	5	16	8	M6	4.5	32	45	60.5
50	20	14.5	32	53	6	6	68	G1/8	M3	71	6	24	8	M8	4.5	50	46	69.5

Stopper cylinders Mod. ST32 (ISO 21287)

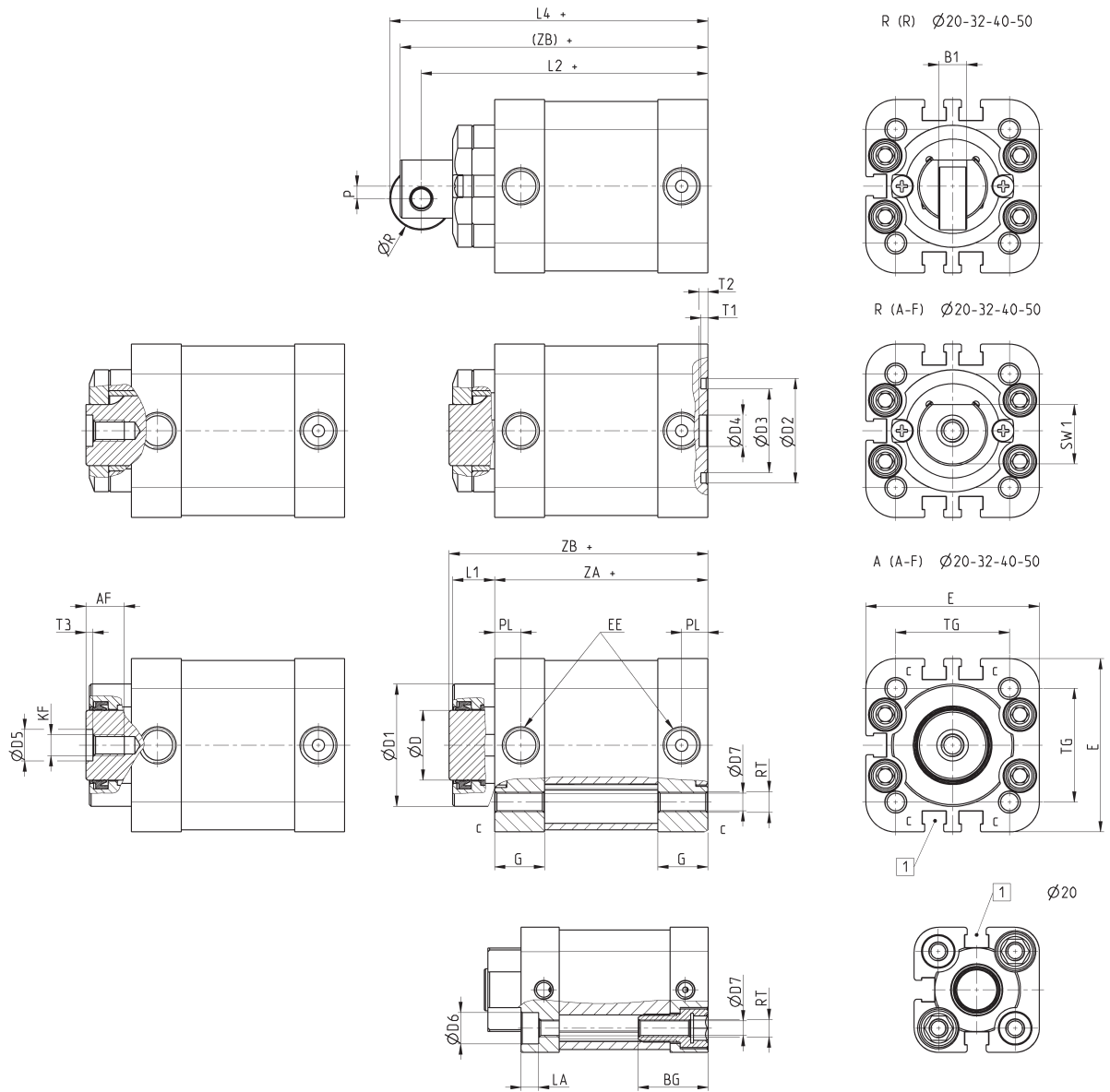

Ø	AF	BG	B1	G	ØD	ØD1	ØD2	ØD3	ØD4	ØD5	ØD6	ØD7	E	EE	KF	LA	L1	L2	L4	P	PL	ØR	RT	SW1	T1	T2	T3	TG	ZA	ZB	(ZB)
20	6	20	4	10.9	12	25	-	-	9	5	9	4	35.8	M5	M3	5	9.5	68	73	2	6.5	10	M5	10	-	2.5	1.2	22	53.5	64	71
32	11	-	8	14.3	20	35	30	24	9	9	-	5	49.6	G1/8	M6	-	12	82	91	3.5	7.6	18	M6	17.5	2	2.5	2	32.5	61	74	88
40	14.5	-	8	14.3	25	43	35	29	12	12	-	5	57	G1/8	M8	-	12.5	90	101	5	7.6	22	M6	22	2	2.5	2.5	38	66.5	80	97
50	14.5	-	10	14.3	32	51	40	34	12	12	-	6	69.6	G1/8	M8	-	14.5	92.5	105	7	7.6	25	M8	28	2	3	2.5	46.5	65.5	81	100

Products designed for industrial applications.
General terms and conditions for sale are available on www.camozzi.com.